

APR™ Adjustable Passive Radiators

CSS is pleased to announce their new patent-pending Adjustable Passive Radiators (APR). These come in 10", 12" and 15" sizes and all feature a unique centre tube which allows additional weight disks to be added even after the unit has been mounting in an enclosure.

The cap on the centre tube can be unscrewed allowing weight disks or washers to be added to the tube. The centre bolt is threaded and permits the enclosed washers to be put on top of the last weight added. The wing nut can then be used to tighten everything down.

Each APR™ comes with 20 50 gram disks.

Preliminary parameters

APR 10:

Sd: 320 cm²
Qms 7
Cms 0.48 mm/N
Rms 3 Kg/s
Vap: 67 liters
Mmp: 66 grams
Fp: 28 Hz
Xsus: 26mm one way
Maximum moving mass: 1200 grams
Minimum Fp: 6.7 Hz (with full 1200 gram moving mass)

APR 12:

Sd: 505 cm²
Qms 7
Cms 0.48 mm/N
Rms 3 Kg/s
Vap: 156 liters
Mmp: 94 grams
Fp: 25 Hz
Xsus: 29mm one way
Maximum moving mass: 1200 grams
Minimum Fp: 6.9 Hz

APR15:

Sd: 800 cm²
Qms 7
Cms 0.48 mm/N
Rms 3 Kg/s
Vap: 463 liters
Mmp: 135 grams
Fp: 19 Hz
Xsus: 33mm one way
Maximum moving mass: 1200 grams
Minimum Fp: 6.4 Hz



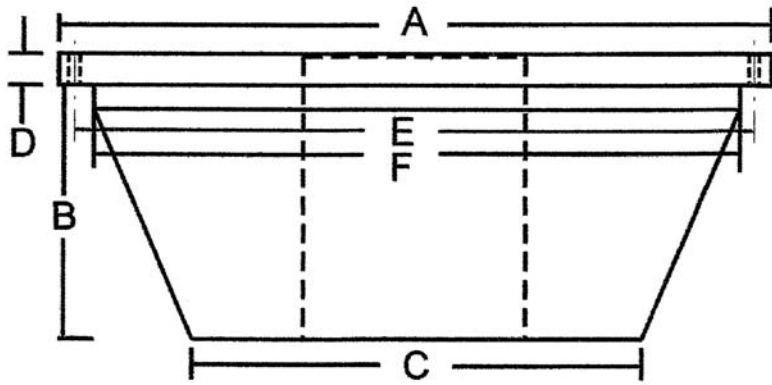

Mounting Dimensions

	10"	12"	15"
A	260	313	390
B	80	97.8	137
C	150	180	170
D	12	13.5	17
E	248	295.2	374
F	232	280	354

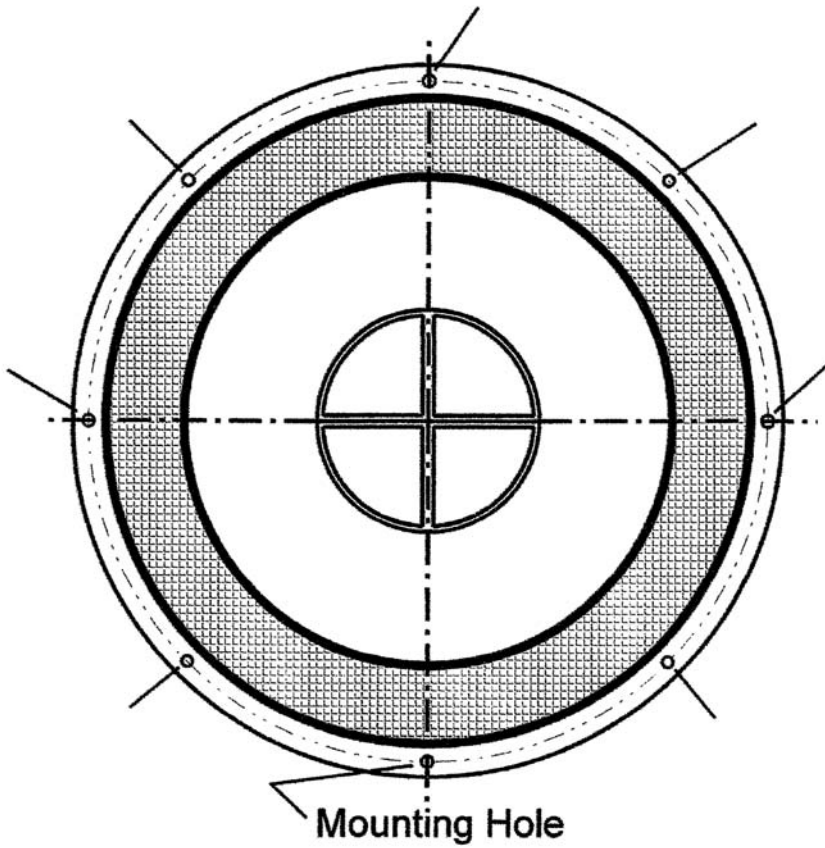

All dimensions in millimetres
Mounting Holes 5 x 8 mm